

PROJECT			
DATE		TYPE	

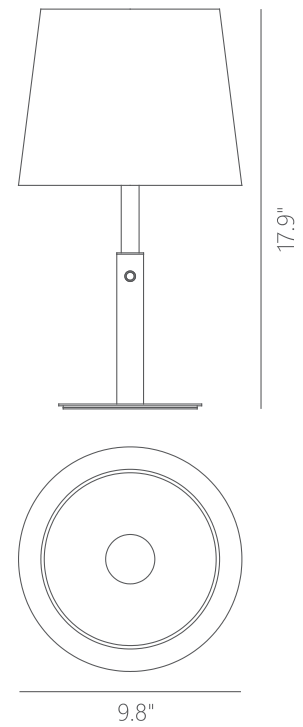

PT040013-DT/CW



BAMBI

Materials:
Aluminum, Fabric

Color Temp.:
3000K

Lamp Shade:
CW - Cream White

CRI (Ra):
≥90

Finish:
DT - Deep Taupe

LED Rated Life:
≈50,000 Hours



PT040013

Wattage: 9W
Voltage: 100~240V
Total Lumens: 750
Delivered Lumens: 226