

# Users' Manual

**PAGEONE**

ITEM NO: PW030027-BC

lighting

FIGURE Nº 1. UNPACK THE FIXTURE: CHECK THE CONTENTS OF THE BOX. YOU SHOULD RECEIVE ITEMS AS BELOW

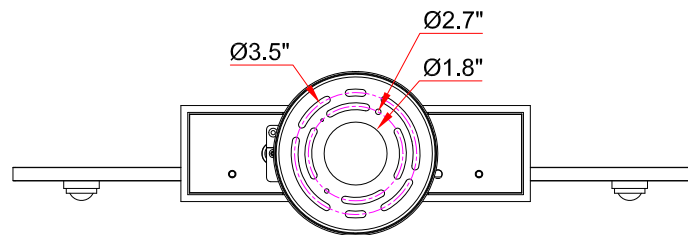
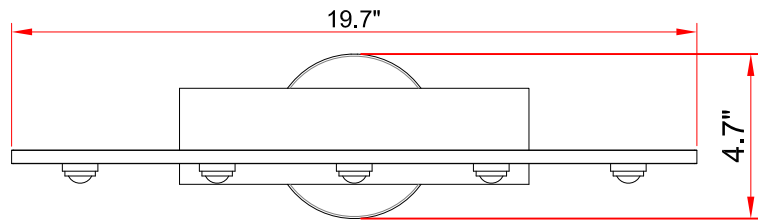
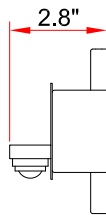
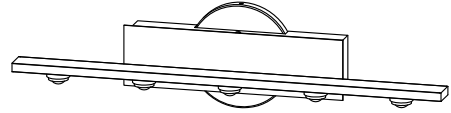
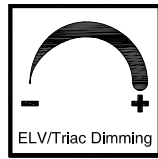

## INSTALLATION INSTRUCTIONS FOR HANGING FIXTURES

FIGURE 1, 2, 3 AND 4 MOUNTING HARDWARE.

**NOTE: TEST THE CONNECTOR BY GENTLY PULLING IT. IF IT PULLS OUT THE CONNECTION, TRY AGAIN TILL YOU HAVE A FIRM CONNECTION. MAKE SURE NO BARE STRANDS OF WIRE STICK OUT FROM UNDER THE CONNECTORS.**

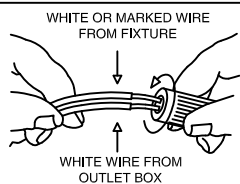

FIGURE 1

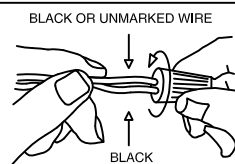

FIGURE 2

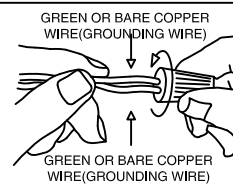

FIGURE 3



FIGURE 4

### CAUTION:

"Warning", "This product is to be installed by a qualified electrician only."  
"Suitable for dry locations only"

#### CAUTION:

- 1.- Wrong lighting installation can be dangerous for your safety.
- 2.- Before starting, disconnect the power by turning off the general switch of the electric installation.
- 3.- Install light bulbs (not provided) that must not exceed markings on the fixture.
- 4.- To change the bulbs, disconnect the power by turning off the general switch and wait for the bulbs cool down.

#### INSTALLATION:

1.- Make electrical connections, carefully read the Electrical Connection section.

2.- Assemble lighting onto the outlet box as shown on back page

ELECTRICAL CONNECTIONS: (See fig. 1, &2, &3, &4)

- 1.- Connect the white wire from the fixture to the white wire of the electric installation.
- 2.- Connect the black wire from the fixture to the black wire of the electric installation.
- 3.- Connect the grounding conductor from the fixture to the grounding wire of the electric installation.
- 4.- Spread out the electrical wires so that the black ones are on one side of the outlet box and the white ones are on the other side, and carefully introduce them into the outlet box.

# Installation Instructions Sections

**PAGEONE**  
lighting

ITEM NO: PW030027-BC

**A**

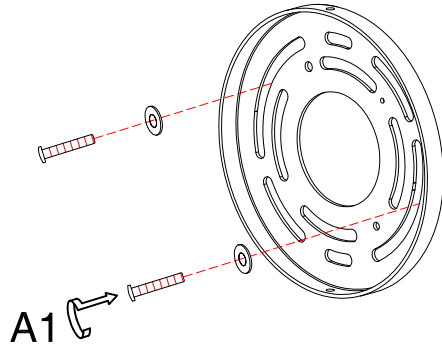

**B**

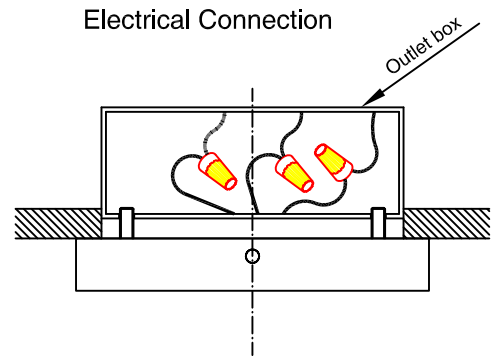

**C**

