

Features

- Solid brass construction
- One piece cast spout design
- Base with integral O-ring deck seal
- Removable spout for above deck refilling
- 8 fluid oz. (236 ml) capacity bottle included
- 1-3/8" (3.5 cm) spout height at outlet
- 3-1/2" (8.9 cm) spout reach (c-c)
- Complements Zemora Series

Soap/Lotion Dispenser

3160-5721

Also 20-220, 125-8 and 125-9

Codes / Standards Compliance

Meets or exceeds the following at date of manufacture:

- All applicable US Federal and State material regulations

Colors / Finishes

- 10B: Oil Rubbed Bronze
- 15: Polished Nickel
- 15S: Satin Nickel - PVD
- 26: Polished Chrome
- Other: Refer to the Newport Brass catalog for additional color/finish options.



3160-5721



20-220



125-8



125-9

Specified Model

Model	Description	Colors Finishes
3160-5721	Soap/Lotion Dispenser	<input type="checkbox"/> 10B <input type="checkbox"/> 15 <input type="checkbox"/> 15S <input type="checkbox"/> 26 <input type="checkbox"/> Other
20-220	Soap / Lotion Replacement Pump Head	<input type="checkbox"/> 10B <input type="checkbox"/> 15 <input type="checkbox"/> 15S <input type="checkbox"/> 26 <input type="checkbox"/> Other
125-8	Soap / Lotion Replacement Pump	
125-9	Soap / Lotion Replacement Bottle	

* Note: Requires 1-1/4" to 1-11/16" through hole. Accommodates 2-1/4" maximum deck thickness.

Product Specification Add "Color / Finish" suffix to Model number, below.

The Soap / Lotion Dispenser shall be made of solid brass construction. Dispenser shall incorporate a removable top spout assembly for easy refilling access. Dispenser shall incorporate a refillable 8 fluid ounce (236 ml) capacity container. Product shall incorporate a 1-3/8" (3.5 cm) spout height at outlet and a 3-1/2" (8.9 cm) spout reach (c-c). Soap / Lotion Dispenser shall be Newport Brass Model 3160-5721/____.

3160-5721

PRODUCT DIMENSIONS *(Units are in inches)*

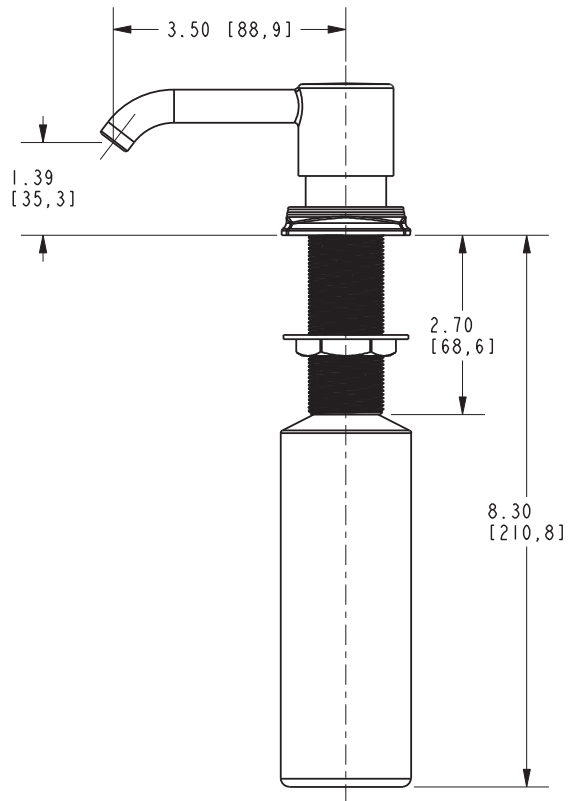
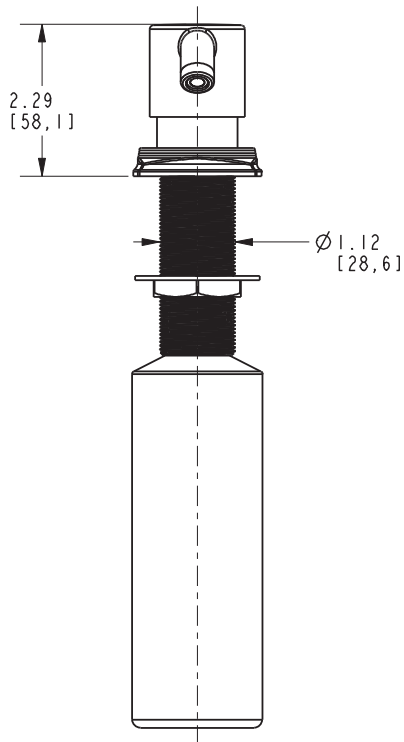
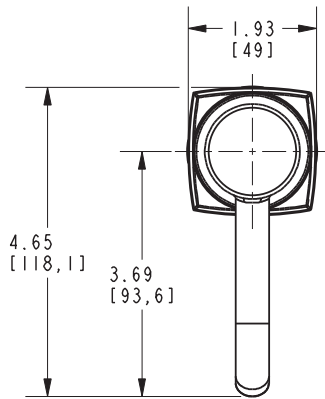

Zemora Soap/Lotion Dispenser
3160-5721