

Commercial
Pressure Balance Trim E
 Finishes : **chrome** Part no. : **04496000**



Description

Features

- Flow: 5.5 GPM (20.6 L/Min)
- Integrated bypass for use with diverter tub spouts
- Temperature and on/off control for 1 outlet

Item details

List Price \$ 185.00

Compliance



Product image



Scale drawing

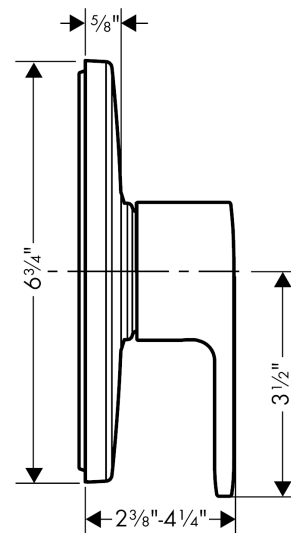

Commercial
Pressure Balance Trim E
Finishes : **chrome** Part no. : **04496000**



Exploded drawing

Year of production: >08/12

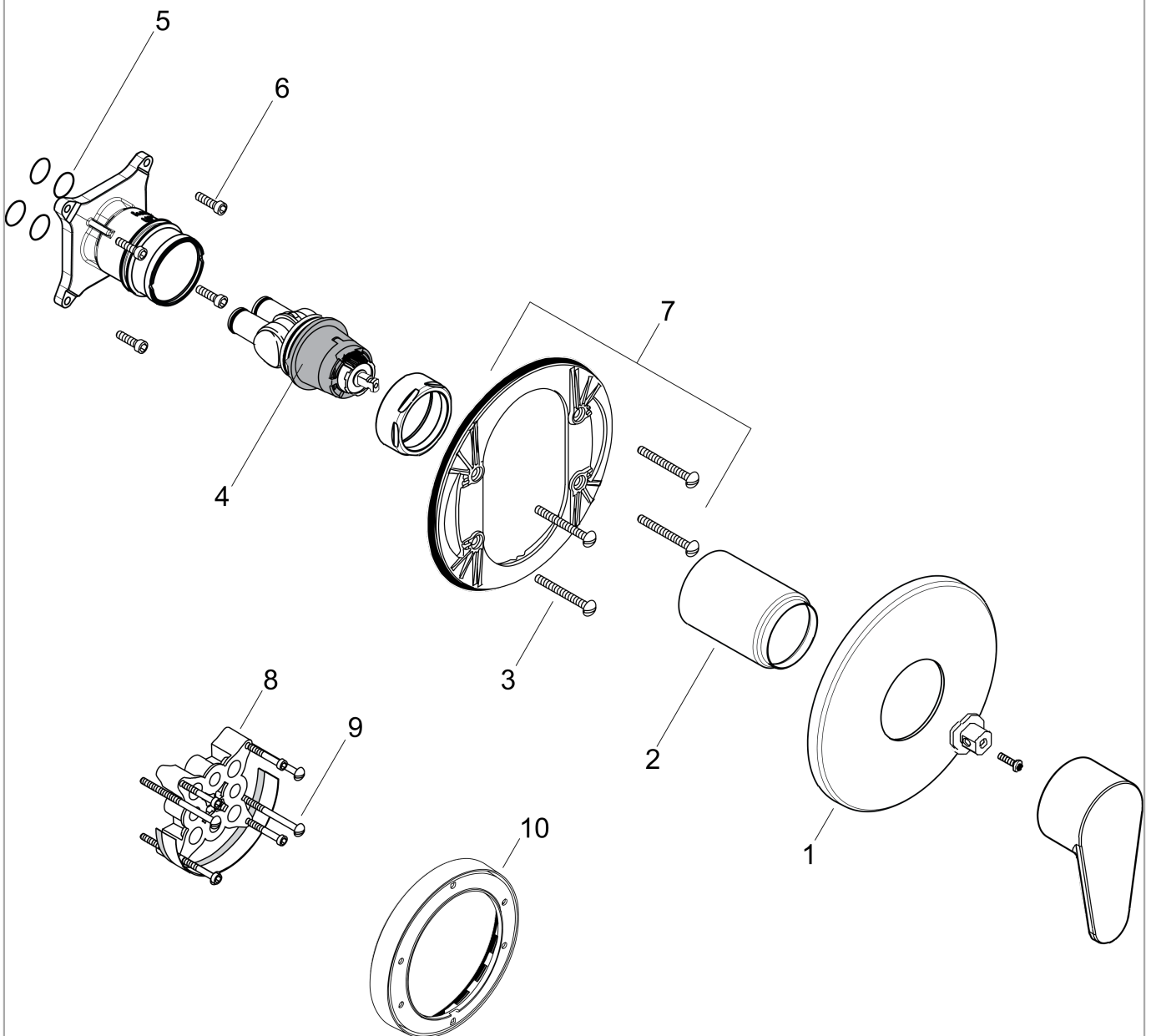

Commercial

Pressure Balance Trim E

Finishes : **chrome** Part no. : **04496000**



Spare parts list

Year of production: >08/12

Pos.	Description	Part no.	Price	PU
1	escutcheon	88760000	-	1
2	sleeve	88765000	-	1
3	set of fixing screws	96454000	-	1
4	cartridge, assy	88727000	-	1
5	O-ring 16x2	98133000	-	1
6	set of screws	96525000	-	1
7	sub plate	96447000	-	1
8	extension 25 mm	13595000	-	1
9	set of fixing screws	97747000	-	1
10	extension 22 mm (Ø 170 mm)	13596000	-	1