

Installation manual for 3502W32C

Dimensions : W31.9"*H4.5"*E2.2"

Collection : Monroe

Bulb Type : LED PCB 23W 4000K

Lamp Weight :7.3LBS

Total Weight :8.6LBS



Thank you for choosing our product(s).



Our Company is actively involved in every step of the production.

Our product(s) are designed to be utilized for every application that graces your home or business.

We pride ourselves in providing the most prompt and courtesy service to all of the valued customers.

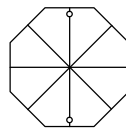
Please find the enclosed detailed instructions and read carefully for proper installation. If you have any questions, our professional customer service team is committed to assisting you, please call our toll free HOTLINE AT:



1-888-388-3390   US

3502W32 W31.9"*H4.5"*E2.2"

SAFETY

Warning: MAKE SURE THE ELECTRICITY TO THE WIRES YOU ARE WORKING ON IS SHUT OFF. BY EITHER REMOVING THE FUSE OR TURNING OFF THE CIRCUIT BREAKER.

CAUTION

- Before assembling the lighting fixture, please read all instructions carefully.
- All frame & crystal components are fragile, please handle with care.
- Required supply circuit : 110 - 130V/60Hz
- Labeled wires are "L" for live wire, "N" for neutral wire, "E" for ground wire.
- Never install fixture on damp ceiling, the room should be dry and well ventilated
- All electrical components must be installed by a licensed electrician and in accordance with the National Electrical Code and the appropriate local electrical codes.

Unpack the Package

Please open the box carefully and check all the items are inside the box. If you have any installation, assembling and missing parts questions, please call our Customer Service department at 1-888-388-3390. Please have model number(at the front page), where you purchase from and any other relevant information ready, our customer service team will provide comprehensive and worry free service to our valued customers.

①

3502W32 W31.9"*H4.5"*E2.2"

Frame Assembly Diagram

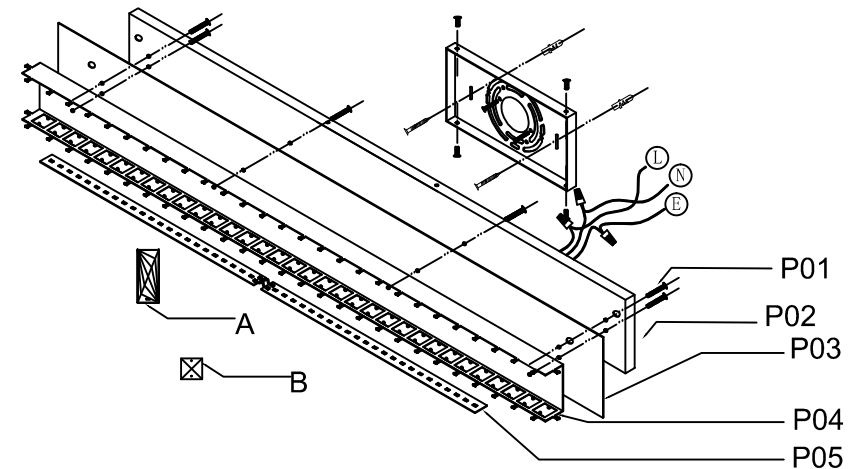















②

3502W32 W31.9"*H4.5"*E2.2"

Step 1

Please use the partslist to ensure you are not missing any parts.

3502W32 PARTS LIST

Part #	Picture	Description	Qty	Check list
ZA		9"*4" bracket	1	
ZB		M4*15 screw	4	
ZC		1.2" screw	4	
ZD		5/32*40 screw	2	
ZE		junction caps	3	
ZF		plastic anchor screw	2	
ZG		junction box (not included)	1	
P01		M4*20 screw	6	
P02		29"*4"*T0.6" back box	1	
P03		32"*4.5" S.S plate	1	
P04		31"*5.7" S.S frame	1	
P05		L17.6"*W0.8" high voltage LED PCB	1	
P06		L11.6"*W0.8" high voltage LED PCB	1	
A		1.2"*3" crystal	26	
B		22# square crystal	29	

3502W32 W31.9"*H4.5"*E2.2"

Part #	Picture	Description	Qty	Check list

3502W32 W31.9"*H4.5"*E2.2"

Step 2

Canopy Installation Instruction

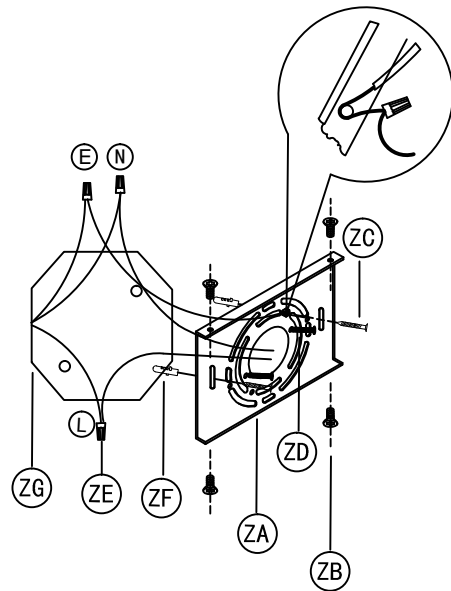

1. Drill two holes on the wall and put the plastic anchor screw into the holes (If the wall is wood made, this step can be ignored);
2. Attach the Bracket (ZA) to the Junction Box (ZG) with two screws (ZD). Fix (ZA) on the wall with screw (ZC);
3. Connect the wires with electrician approved junction caps (ZE).

05

3502W32 W31.9"*H4.5"*E2.2"

Step 3

Frame Assembly Diagram

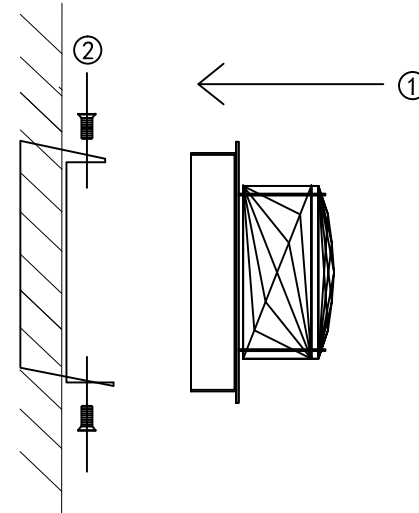

Frame Assembly Instructions

Installation:

Please read all instructions carefully, before you proceed to install. Make sure that the power supply is turned off and remained off until the installation is completed. Please note that each step has been assigned a number. Please proceed following the numerical order.

1. put the fixture on the bracket;
2. fix the fixture on the bracket with screw (ZB);

06

3502W32 W31.9"*H4.5"*E2.2"

Congratulations!

You are now done installing your Elegant lighting fixture. Sit back and admire each crystal as it will become the statement piece for your room/house.

If you require any additional assistance, please contact us at 1-888-388-3390.

Thank you!

07

3502W32 W31.9"*H4.5"*E2.2"

Cleaning and Maintenance Instruction

The frame and canopy surface is stainless polished. Please use a clean, soft and dry cloth to clean. Do not use any hard object or tools to scratch on the surface of the metal. Failure to follow these instructions automatically voids the guarantee.

Cleaning and Maintenance of Crystals

Wet a soft cotton fabric in clean warm water and wipe gently, then polish with a dry soft cotton fabric.

To Order Replacement Parts

Please contact the store where the product was purchased or contact us at the address shown on the reverse side. For ease of ordering, you may use the original parts list, indicating the model number, part number and quantity and faxing it to our customer service department at 215-423-8882. You will be contacted with prices prior to shipment. All orders must be pre-paid.

08

3502W32 W31.9"*H4.5"*E2.2"

Elegant Lighting Warranty

The finish and frame of your new chandelier or fixture are warranted for a period of two (2) years from the date of purchase. Our company will, at its option, repair or replace any frame that has a defect in the materials or workmanship during the warranty period. All crystals are guaranteed for their original quality during the life of the chandelier. Breakage is not covered by this warranty.

To make a claim under this warranty, contact our customer service department at the address and phone number shown below. A written return authorization form will be sent to you with specific instructions.

CUSTOMER SERVICE DEPARTMENT
500-550 E. Erie Avenue
Philadelphia, PA 19134
Tel : 215-423-8880
Fax : 215-423-8882

3502W32 W31.9"*H4.5"*E2.2"

Returns and Conditions of Warranty

Returns must be pre-authorized by contacting our customer service department at the address on the reverse side. Returns will only be accepted with a written return merchandise authorization and return shipping charges pre-paid. We reserve the right to inspect all returned merchandise to fully determine the nature of any defect. This guarantee shall not apply to any product that has been changed, altered or otherwise modified, nor shall it apply to any product that has been repaired or altered by anyone other than a pre-authorized facility. We will not be responsible for any breakage or damages incurred during transit, nor for crystal parts or metal frame part that have been subject to misuse, negligence, accident or inappropriate handling. Also, we will not be held responsible for damage incurred during improper installation or wiring by others, nor for damages resulting from a failure to follow the recommended maintenance or installation procedures. This guarantee is issued in lieu of any and all other guaranteed or warranty, whether written or implied and any and all other obligations or liabilities. Further, we neither authorize nor permit any other person or firm to assume for us, any liability in connection with the sale of our products.