

## Installation manual for

V2914D24C/RC

Dimensions : D24" H6.5" L10

Collection : Amelie

Bulb Type : G9 bulb, not include bulbs

Lamp Frame Weight: 21.12 LBS

Total Weight : 24.2 LBS

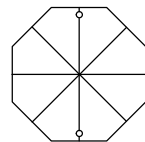

Thank you for choosing our product(s).

Our Company is actively involved in every step of the production.

Our product(s) are designed to be utilized for every application that graces your home or business.

We pride ourselves in providing the most prompt and courtesy service to all of the valued customers.

Please find the enclosed detailed instruction and read carefully for proper installation.

If you have any questions, please contact the retailer Where the purchased was made.

### SAFETY

Warning: MAKE SURE THE ELECTRICITY TO THE WIRES YOU ARE WORKING ON IS SHUT OFF. BY EITHER REMOVING THE FUSE OR TURNING OFF THE CIRCUIT BREAKER.

### CAUTION

- Before assembling the lighting fixture, please read all instructions carefully.
- All frame & crystal components are fragile, please handle with care.
- Required supply circuit : 110 - 130V/60Hz
- Labeled wires are "L" for live wire, "N" for neutral wire, "E" for ground wire.
- Never install fixture on damp ceiling, the room should be dry and well ventilated
- All electrical components must be installed by a licensed electrician and in accordance with the National Electrical Code and the appropriate local electrical codes.

### Unpack the Package

Please open the box carefully and check all the items are inside the box. If you have any installation, assembling and missing parts questions. where you purchase from and any other relevant information ready, our customer service team will provide comprehensive and worry free service to our valued customers.

## Frame Assembly Diagram

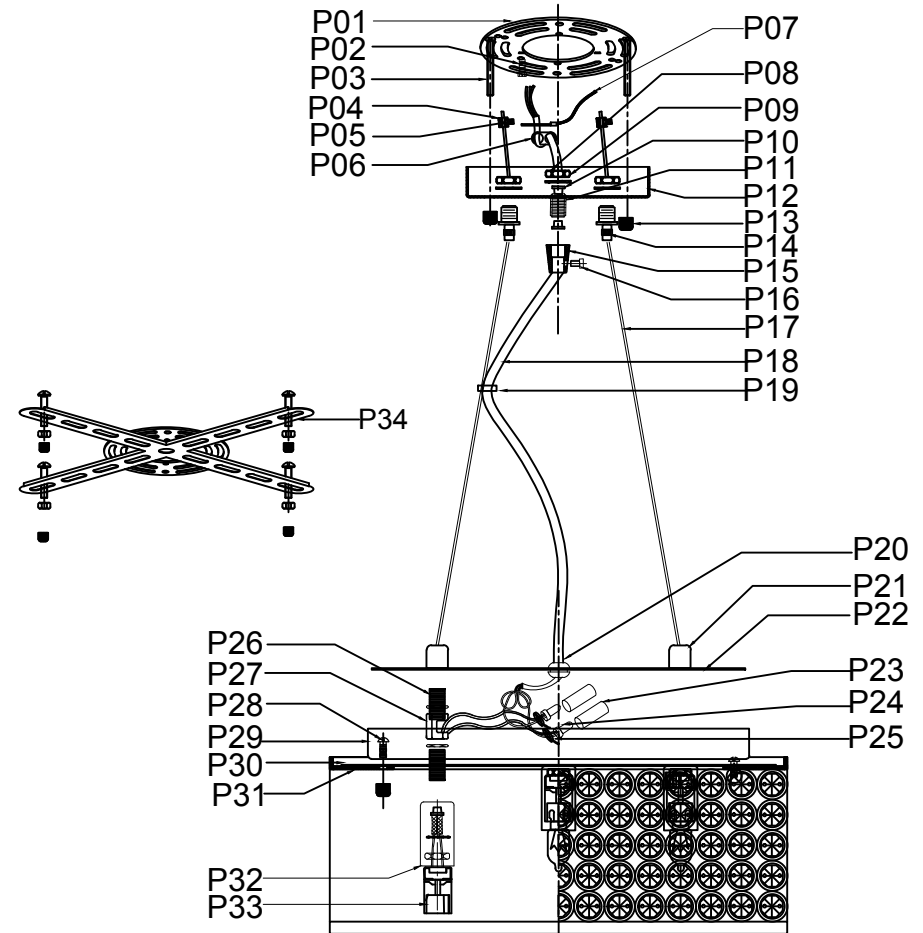













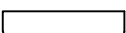

V2914D24C/RC D24" H6.5" L10

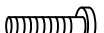
Step 1













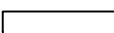

Please use the parts list to ensure you are not missing any parts.









V2914D24C

PARTS LIST

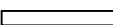
Part #	Picture	Description	Qty	Check list
ZA		Electrical box (not include)	1	
ZB		GND	1	
ZC		Junction Caps	3	
ZD(P01)		Mounting bracket (φ4")	1	
ZE(P12)		Canopy(φ4.7"*H1,Chrome)	1	
ZF(P13)		Knurled nut	13	
ZG		Mounting bracket screw	2	
P01		Mounting bracket (φ4")	1	
P02		Ground screw	1	
P03		Mounting bracket screw	2	
P04		Wire rope clamp	6	
P05		M4 Nipple	6	
P06		Cable buckle	2	
P07		GND	1	
P08		M10 Hex nut	8	

V2914D24C/RC D24" H6.5" L10

Part #	Picture	Description	Qty	Check list
P09		M10 Lock washer	14	
P10		M10 Rubber gasket	24	
P11		M10 Nipple (L0.8")	1	
P12		Canopy(φ4.7"*H1,Chrome)	1	
P13		Knurled nut	13	
P14		Cable adjustment bolt	4	
P15		Power wire adjustment bolt	2	
P16		Plastic nipple	1	
P17		Steel cope (L59")	4	
P18		Clear Round Electrical Wire (L70.8",18#, Clear)	1	
P19		Plastic washer	2	
P20		Rubber gasket	1	
P21		Coupling	4	
P22		Round iron plate (φ21.3*T0.04")	1	
P23		Cable tie	2	
P24		Junction caps	2	
P25		Heat shrink tubing	2	

Part #	Picture	Description	Qty	Check list
P26		M10 Hickey	1	
P27		M10 Nipple (M10*L0.6")	3	
P28		M4 Screw	6	
P29		Canopy (Ø21.6*H1",Silver)	1	
P30		Stainless steel plate (Ø23*T0.03")	1	
P31		Round crystal shade (Ø23.7*H6.9")	1	
P32		Socket cover (Ø0.9*H1.65",Chrome,Iron)	10	
P33		G9 Socket	10	
P34		Mounting bracket (Ø14.5*H0.6")	1	
A		1050-14#*10	49	

Step 2

Canopy Installation Instruction

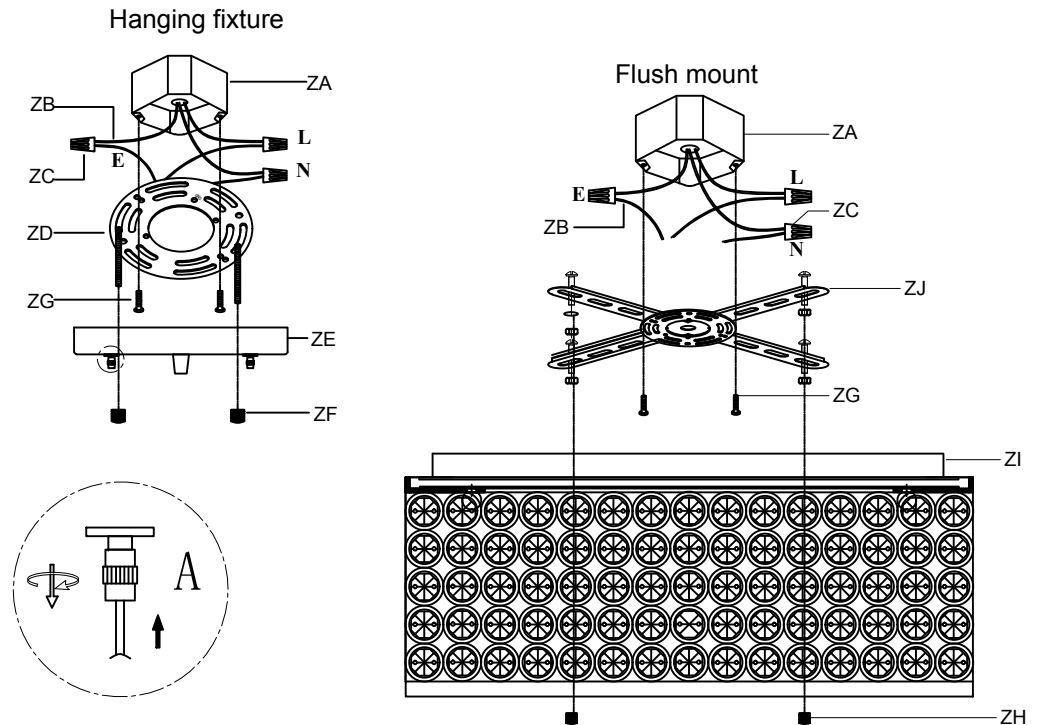

When adjusting the height of the steel wire, the telescopic metal part A toothed outer ring can only twist half a turn, and then pull it up to adjust the height!!!

"L"=Hot wire  
 "N"=Neutral wire  
 "E"=GND

**IMPORTANT:** Test sockets with bulb before dressing the fixture.

- 1 .Attach the Mounting bracket(ZD) to the electrical box(ZA).
- 2 .Pull wires up through the Junction Caps(ZC).
- 3 .Attach the Canopy(ZE) to the ceiling panel.
- 4 .Make the electrical connections as detailed in the drawing above.
5. When you want to use as Flush mount, remove Canopy(ZE), Metal finial(ZF), Cord(P17) and other light body parts, then fasten Mounting bracket(ZJ) on Electrical box(ZA) use Mounting bracket screw(ZG) after connecting the wire, install Canopy(ZI) use Knurled nut(ZH) lastly.

Step 3

## Frame Assembly Diagram

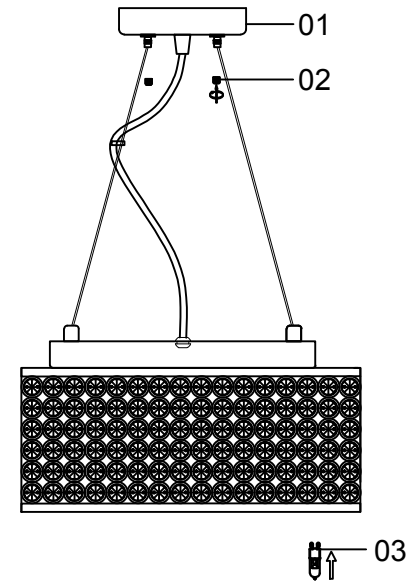

# Frame Assembly Instructions

## Installation:

Please read all instructions carefully. Before you proceed to install make sure that the power supply is turned off and remains off until installation is complete. Please note that each part has been assigned a number. Please proceed in a numerical order.

1. Install Canopy(01) on ceiling panel use Knurled nut (02).
2. Install G9 Bulb(03).

## Step 4 Crystal Dressing Diagram

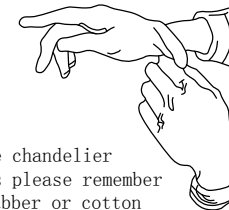

When dressing the chandelier with the crystals please remember to wear either rubber or cotton gloves. So as to prevent any damage or smudging on the crystals.

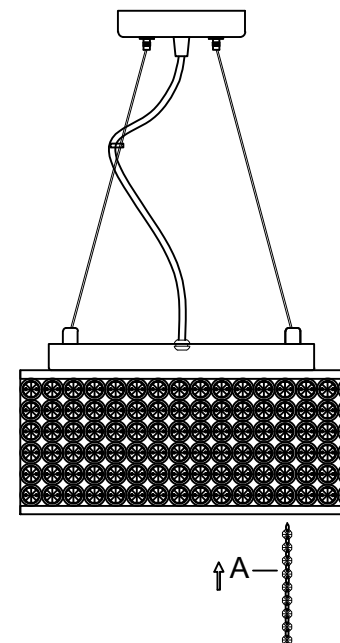

1. Hang Octagon crystal (A).

## Congratulations !

You are now done installing your Elegant Lighting fixture. Sit back and admire each crystal as it will become the statement piece for your room/house.

Thank you.

**Cleaning and Maintenance of Chandelier Frame**  
The finish on our chandelier frames and fixture frames is protected by a durable coating of lacquer. To clean, use a clean soft, dry cloth. Do not use any metal polishes, cleaners, abrasives or any substance which could remove the protective finish. Failure to follow these instructions automatically voids the guarantee.

**Cleaning and Maintenance of Crystals**  
Wet a soft cotton fabric in clean warm water and wipe gently, then polish with a dry soft cotton fabric.

**To Order Crystal Replacement Parts**  
Should you require replacement crystals or pins (the metal connectors attaching the crystals), contact the store where the product was purchased or contact us . For ease of ordering, you may use the original crystal trimming instructions provided with this product and circle the items you wish to order, indicating the quantity by writing the number needed adjacent to the circle . You will be contacted with prices prior to shipment. All orders must be pre-paid.

## Elegant Lighting Warranty

The finish and frame of your new chandelier or fixture are warranted for a period of one (1) year from the date of purchase. Our company will, at its option, repair or replace any frame that has a defect in the materials or workmanship during the warranty period. All crystals are guaranteed for their original quality during the life of the chandelier. Breakage is not covered by this warranty.

To make a claim under this warranty, contact our customer service department.

A written return authorization form will be sent to you with specific instructions.

## Returns and Conditions of Warranty

Returns must be pre-authorized by contacting our customer service department. Returns will only be accepted with a written return merchandise authorization and return shipping charges pre-paid. We reserve the right to inspect all returned merchandise to fully determine the nature of any defect. This guarantee shall not apply to any product that has been changed, altered or otherwise modified, nor shall it apply to any product that has been repaired or altered by anyone other than a pre-authorized facility. We will not be responsible for any breakage or damages incurred during transit, nor for crystal parts or metal frame part that have been subject to misuse, negligence, accident or inappropriate handling. Also, we will not be held responsible for damage incurred during improper installation or wiring by others, nor for damages resulting from a failure to follow the recommended maintenance or installation procedures. This guarantee is issued in lieu of any and all other guaranteed or warranty, whether written or implied and any and all other obligations or liabilities. Further, we neither authorize nor permit any other person or firm to assume for us, any liability in connection with the sale of our products.