

# LIVING DISTRICT

Installation manual for:

LD8801D43C,LD8801D43BK,LD8801D43GB

Dimensions: D43.5"H46"L12

Collection: Cordelia

Bulb Type : E12 bulb not included

Lamp Frame Weight (lbs) : 36.7

Total weight (lbs) : 48.4

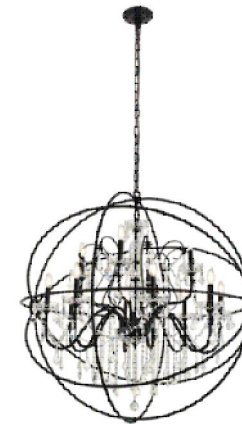

Thank you for choosing world famous brand chandelier. We are providing the finest quality crystal chandelier for our customers. Our master designers and craftsmen intend to give a professional insight on lighting design & product quality. Prompt and efficient services are our priority. We enclosed detail instructions on how to install your chandelier properly. Please read all instructions carefully & thoroughly. If you have any questions, our professional customer service team committed provided all the information of our products, please call our toll free

CHANDELIER HOTLINE AT:

**1-888-388-3390**

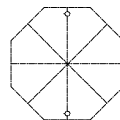

### SAFETY

**Warning: MAKE SURE THE ELECTRICITY TO THE WIRES YOU ARE WORKING ON IS SHUT OFF, BY EITHER REMOVING THE FUSE OR TURNING OFF THE CIRCUIT BREAKER.**

### CAUTION

- Before assembling the lighting fixture, please read all instructions carefully.
- All frame & crystal components are fragile, please handle with care.
- Required supply circuit : 110 - 130V/60Hz
- Labeled wires are "L" for live wire, "N" for neutral wire, "E" for ground wire.
- Never install fixture on damp ceiling, the room should be dry and well ventilated
- All electrical components must be installed by a licensed electrician and in accordance with the National Electrical Code and the appropriate local electrical codes.

### Unpack the Package

Please open the box carefully and check all the items are inside the box. If you have any installation, assembling and missing parts questions, please call our Customer Service department at 1-888-388-3390. Please have model number (at the front page), where you purchase from and any other relevant information ready, our customer service team will provide comprehensive and worry free service to our valued customers.

### Frame Parts List

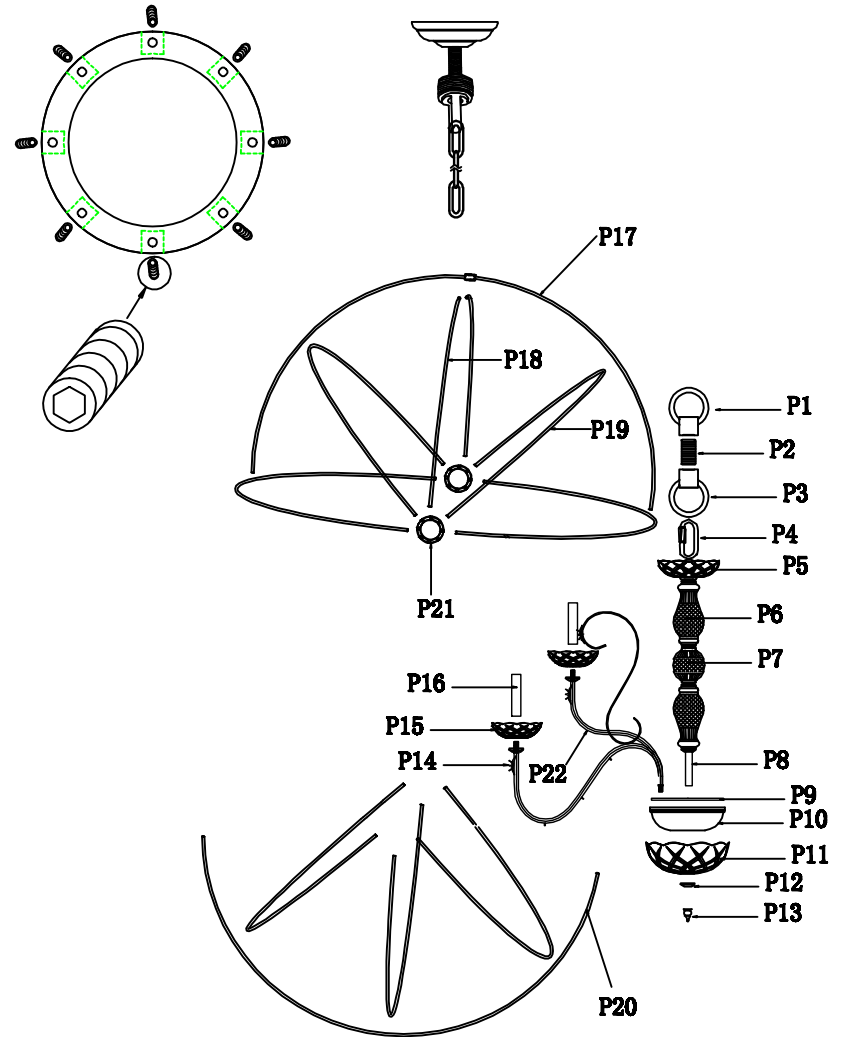











LD8801D43 D43.5"H46"L12

### Step 1

Please use the parts list to ensure you are not missing any parts















LD8801D43

#### PARTS LIST

part	picture	Description	Parts Number	Qty	Check list
ZA		ø5.3" Canopy	CP80R53L3C CP80R53L3BK	1	
ZB		4.1" Crossbar		1	
ZC		Canopy ring		1	
ZD		ø0.4" * 2.6" nipple + loop		1	
ZE		L59" Chain 04P Plain Design	CHAIN04PCH	1	
ZF		Power Cord 79" SPT-1-18# Clear/Brown		1	
P1		ø1.6" Crystal eyelet		1	
P2		ø0.4" * 1.6" nipple		1	
P3		ø1.6" Crystal eyelet		2	
P4		Cover		1	

03

LD8801D43 D43.5"H46"L12

part	picture	Description	Parts Number	Qty	Check list
P5		ø4.7" Glass dish	GD8002A47CL	1	
P6		ø2.2" * 8.5" Glass column	MC8004E65CL	2	
P7		ø3.1" Glass ball	MC8003E31CL	1	
P8		ø0.6" * 3.1" water pipe		1	
P9		ø5.1" Round metal plate		1	
P10		ø5.2" Metal cover		1	
P11		ø7.9" Glass dish	GD8002A79CL	1	
P12		ø1.4" Small plate		1	
P13		Bottom lock		1	
P14		Metal arm		8	
P22		Metal arm		4	
P15		ø4.7" Glass dish	GD8002G47CL	12	
P16		ø0.9" * 4.1" Metal tube		12	
P17		ø0.4" * 1.30.9" Arm-2pcs + ø1.6" Lamp body		1	
P18		ø0.4" * 1.31.1" Arm		2	

04

part	picture	Description	Parts Number	Qty	Check list
P19		∅0.4"*L62.6 Arm	/	7	
P20		∅0.4"*L69.3"+ ∅0.3"*0.8"*2Arm	/	1	
P21		∅3.9"*H0.6" Lamp body	/	2	
A		1050-14#*1+ 911-2"	/	5	
B		1050-14#*2 +911-2.5"	/	8	
C		1050-14#*5-5PCS+ 2024-14#+1050-14# +911-2.5"	/	4	
D		1050-14#*1+ 911-2"	/	60	
E		1050-14#*1 +911-2.5"	/	4	
F		1050-14#*1 +911-2.5"	/	8	
G		1050-14#*8-8PCS+ 2024-14#+1050-14# +911-2.5"	/	8	
H		1050-14#*1 +911-2.5"	/	8	
I		1050-14#*6+ 911-2.5"	/	8	
J		1050-14#*12+ 911-2.5"	/	8	
K		1050-14#*11+ 911-2.5"	/	6	
L		1050-14#*11+ 701-40#	/	1	

### Canopy Installation Instruction

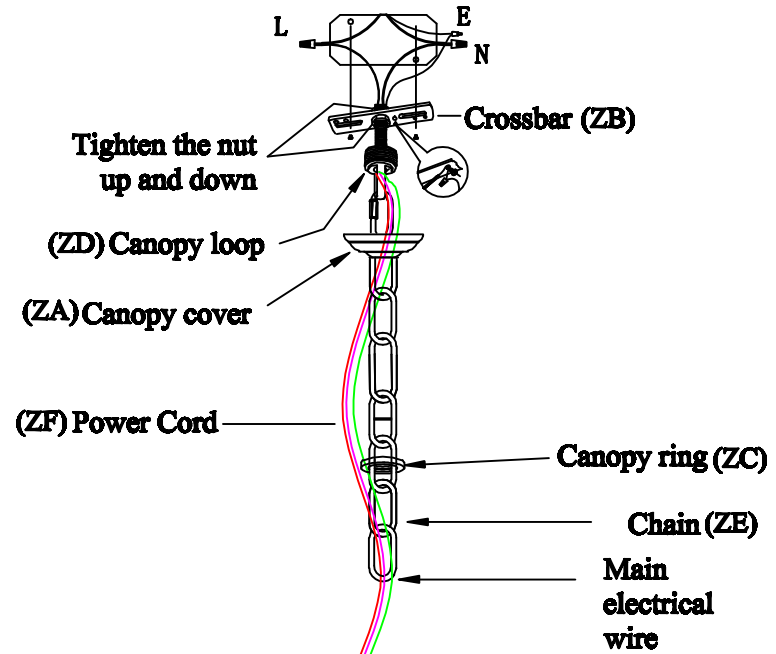

"L" = Hot wite  
 "N" = Neutral wite  
 "E" = Ground wite

LD8801D32 D32"H34.5"L8

**IMPORTANT:** Test sockets with bulb before dressing the fixture.

1. Attach the crossbar to the electrical box.
2. Pass the lamp wire and ground wire through the loop, canopy ring and center hole of canopy cover.
3. Screw 2.5" nipple into the crossbar and fasten with hex-nut.
4. Pull wires up through the nipple.
5. Screw loop only onto threaded pipe.
6. Hang the fixture on chain.
7. Make the electrical connections as detailed in the drawing above.
8. Secure the canopy cover with threaded canopy ring

07

LD8801D43 D43.5"H46"L12

## Frame Assembly Diagram

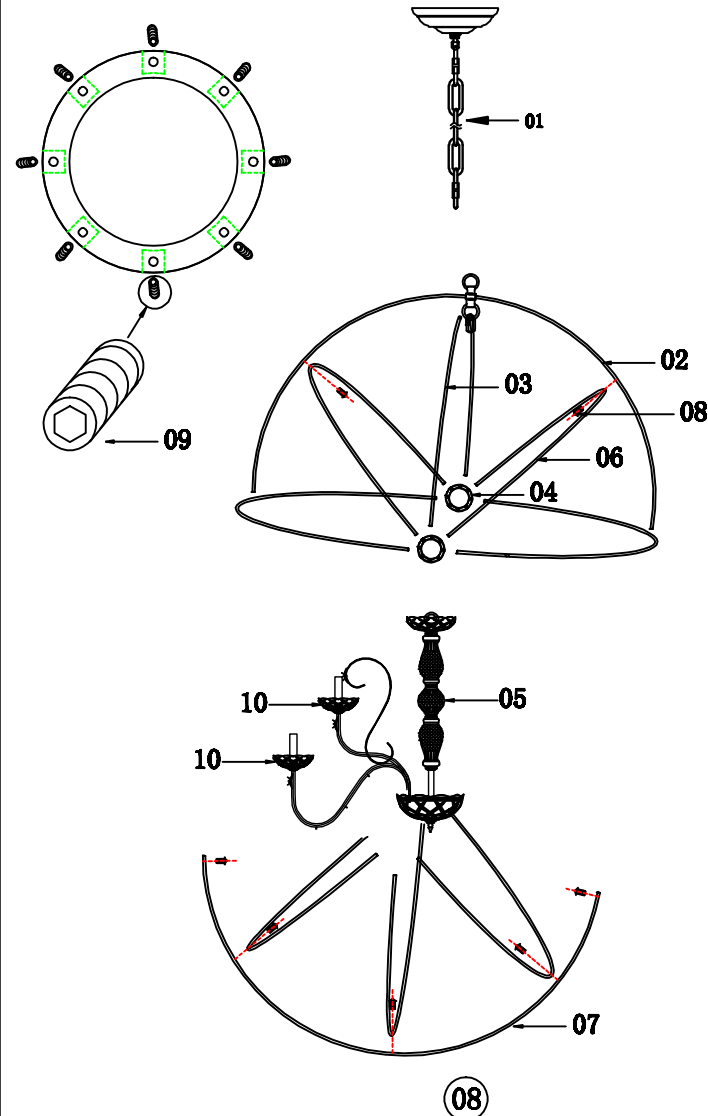

08

## Step 3

# Frame Assembly Instructions

### Installation:

Please read all instructions carefully.

Before you proceed to install, make sure that the power supply is turned off and remains off until installation is complete.

Please note that each part has been assigned a number.

Please proceed in a numerical order.

1. Hang the chain(01) on the ceiling.
2. Hang the lamp body(02) on the chain(01).
3. Install metal arm(03) on the lamp body(02) with Screw(09).
4. Install lamp body(04) on the metal arm(03) with Screw(09).
5. Hang the main body(05) on the lamp body(02), pass the main line through the lamp body(02), and correctly connect the wires .
6. Put the glass dish(10) on the metal arm.
7. Install the metal arm(06) to lamp body(04) with Screws(09).
8. Connect metal armw(07) and lamp body(02) with Screws(09).
9. The metal arm(06) is fixed to the lamp body(02) and the metal arm(07) with Screws(08).

The end!

09

## Crystal Dressing Diagram



When dressing the chandelier with the crystals please remember to wear either rubber or cotton gloves. So as to prevent any damage or smudging on the crystals.

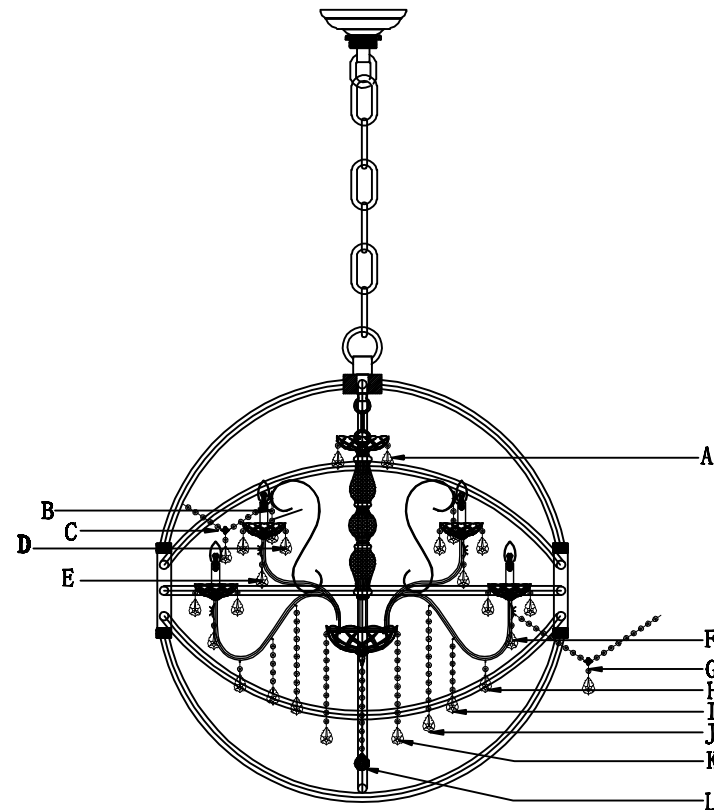

10

## Step 4

### Crystal Dressing Diagram

10. Hang crystal "A", "B", "C", "D", "E", "F", "G", "H", "I", "J", "K", "L"

## Congratulations !

You are now done installing your Elegant Lighting fixture. Sit back and admire each crystal as it will become the statement piece for your room/house.

If you require any additional assistance, please contact us at 1-888-388-3390.

Thank you.

LD8801D43 D43. 5"H46"L12

### Cleaning and Maintenance of Chandelier Frame

The finish on our chandelier frames and fixture frames is protected by a durable coating of lacquer. To clean, use a clean, soft, dry cloth. Do not use any metal polishes, cleaners, abrasives or any substance which could remove the protective finish. Failure to follow these instructions automatically voids the guarantee.

### Cleaning and Maintenance of Crystals

Wet a soft cotton fabric in clean warm water and wipe gently, then polish with a dry soft cotton fabric.

### To Order Crystal Replacement Parts

Should you require replacement crystals or pins (the metal connectors attaching the crystals), contact the store where the product was purchased or contact us at the address shown on the reverse side. For ease of ordering, you may use the original crystal trimming instructions provided with this product and circle the items you wish to order, indicating the quantity by writing the number needed adjacent to the circle and faxing it to our customer service department at 215-423-8882. You will be contacted with prices prior to shipment. All orders must be pre-paid.

LD8801D43 D43. 5"H46"L12

### Elegant Lighting Warranty

The finish and frame of your new chandelier or fixture are warranted for a period of two (2) years from the date of purchase. Our company will at its option, repair or replace any frame that has a defect in the material or workmanship during the warranty period. All crystals are guaranteed for their original quality during the life of the chandelier. Breakage is not covered by this warranty.

To make a claim under this warranty, contact our customer service department at the address and phone number shown below. A written return authorization form will be sent to you with specific instructions.

CUSTOMER SERVICE DEPARTMENT  
500-550 E. Erie Avenue  
Philadelphia, PA 19134  
Tel: 215-423-8880  
Fax: 215-423-8882



### Returns and Conditions of Warranty

Returns must be pre-authorized by contacting our customer service department at the address on the reverse side. Returns will only be accepted with a written return merchandise authorization and return shipping charges pre-paid. We reserve the right to inspect all returned merchandise to fully determine the nature of any defect. This guarantee shall not apply to any product that has been changed, altered or otherwise modified, nor shall it apply to any product that has been repaired or altered by anyone other than a pre-authorized facility. We will not be responsible for any breakage or damages incurred during transit, nor for crystal parts or metal frame part that have been subject to misuse, negligence, accident or inappropriate handling. Also, we will not be held responsible for damage incurred during improper installation or wiring by others, nor for damages resulting from a failure to follow the recommended maintenance or installation procedures. This guarantee is issued in lieu of any and all other guaranteed or warranty, whether written or implied and any and all other obligations or liabilities.

Further, we neither authorize nor permit any other person or firm to assume for us, any liability in connection with the sale of our products.