

LIVING DISTRICT

Collection:Forte

Installation manual for:

LD4023D14 D13.8"H7.6"L1







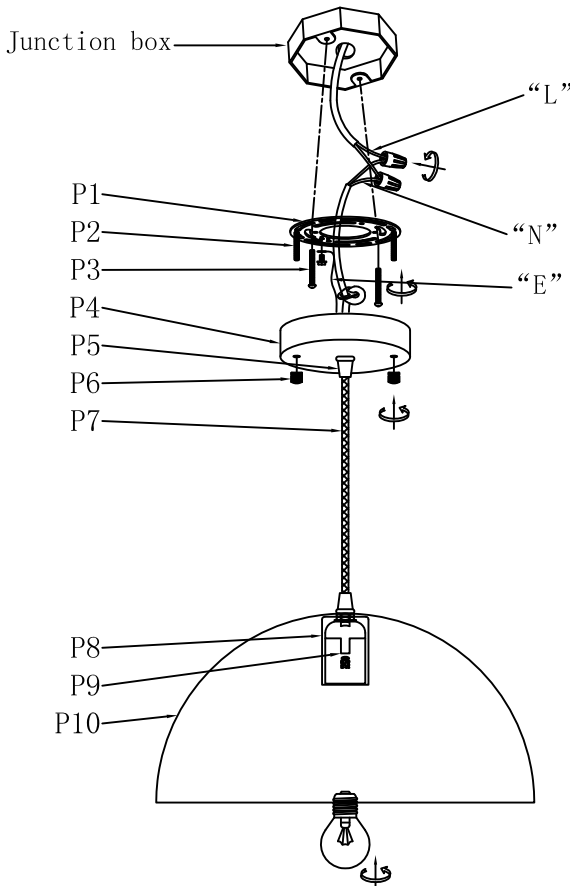

Installation instructions:

- 1.Using the screw (P3) secure the mounting bracket (P1) to the junction box.
2. Black wire from ceiling(junction box) attaches to "L"wire from the fixture.
- 3.White wire from ceiling(junction box) attaches to "N"wire from the fixture.
4. "E" wire from the fixture is attached to the mounting bracket and an additional "E" wire from the mounting bracket must be secured to the junction box.
- 5.M4 screw (P2)pass through the holes in canopy plate and tighten by nut (P6).
- 6.Install the bulb(not included) in lamp holder (P9).

The end!

PARTS LIST

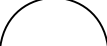

part	picture	Description	Qty	Check list
P1		φ4.0" Mounting bracket	1	
P2		M4 Screw	2	
P3		5/32-32 Screw	2	
P4		φ4.7" Canopy plat	1	
P5		φ0.7"Wire lock	2	
P6		Nut	2	
P7		Power Cord 59" 18# Black	1	
P8		E26 Lamp cup	1	
P9		E26 Lamp holder	1	
P10		13.8"Lampshade	1	

"L" = Hot wire

"N" = Neutral wire

"E" = Ground wire